

BULLDOGKLEMMEN
 BULLDOG CLAMPS
 CLAMPS BULLDOG



DIEFFENBACH
 23E-001 3,5 cm
 23E-002 5,0 cm



DIEFFENBACH
 23E-003 3,5 cm
 23E-004 5,0 cm



JOHNS HOPKINS



23E-005 4,0 cm
 23E-006 5,0 cm
 23E-007 6,0 cm
 23E-008 6,5 cm
 23E-009 7,0 cm
 23E-010 7,5 cm
 23E-011 9,0 cm



23E-012 4,0 cm
 23E-013 5,0 cm
 23E-014 6,0 cm
 23E-015 6,5 cm
 23E-016 7,0 cm
 23E-017 7,5 cm
 23E-018 9,0 cm

ATRAUMATISCHE BULLDOGKLEMMEN
NON TRAUMATIC BULLDOG CLAMPS
CLAMPS BULLDOG A MORS NON TRAUMATISANTS



DeBakey

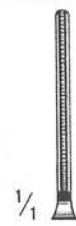

$\frac{1}{4}$
23E-019
7,5 cm



$\frac{1}{4}$
23E-020
8,5 cm



$\frac{1}{4}$
23E-021
10,5 cm



$\frac{1}{4}$
23E-022
12,0 cm



DeBakey

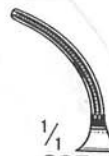

$\frac{1}{4}$
23E-023
7,0 cm



$\frac{1}{4}$
23E-024
8,0 cm



$\frac{1}{4}$
23E-025
10,0 cm



$\frac{1}{4}$
23E-026
11,5 cm

ATRAUMATISCHE BULLDOGGKLEMMEN
NON-TRAUMATIC BULLDOG CLAMPS
CLAMPS BULLDOG A MORS NON TRAUMATISANTS

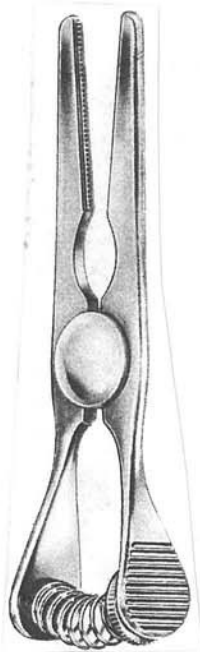

Glover



23E-060
6,0 cm



23E-061
7,0 cm



23E-062
9,0 cm



23E-063
11,0 cm

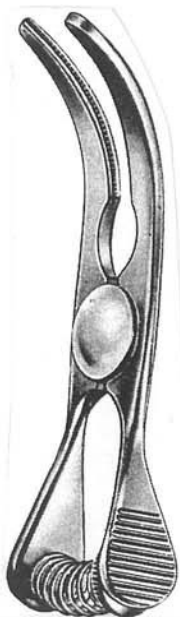

Glover



23E-064
5,5 cm



23E-065
6,5 cm



23E-066
8,5 cm



23E-067
10,5 cm

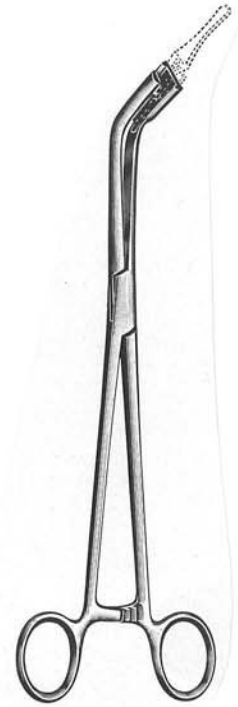

23E-070
23 cm

ATRAUMATISCHE GEFÄSSPINZETTEN
NON TRAUMATIC VESSEL FORCEPS
PINCES VASCULAIRES à MORS NON TRAUMATISANTS



DeBakey-Adson
23E-027 12,0 cm



DeBakey



		1,5 mm	2,0 mm	2,4 mm	2,7 mm	3,5 mm
16 cm	23E-028	23E-032	23E-044	23E-048	23E-052	
20 cm	23E-029	23E-033	23E-045	23E-049	23E-053	
24 cm	23E-030	23E-034	23E-046	23E-050	23E-054	
30 cm	23E-031	23E-035	23E-047	23E-051	23E-055	



		2,0 mm	3,5 mm
16 cm	23E-036	23E-040	
20 cm	23E-037	23E-041	
24 cm	23E-038	23E-042	
30 cm	23E-039	23E-043	

ATRAUMATISCHE GEFÄSSKLEMMEN
NON TRAUMATIC VASCULAR CLAMPS
PINCES VASCULAIRES à MORS NON TRAUMATISANTS



DeBakey-Mosquito



23E-100

12 cm

23E-103

18 cm



23E-104

23E-107

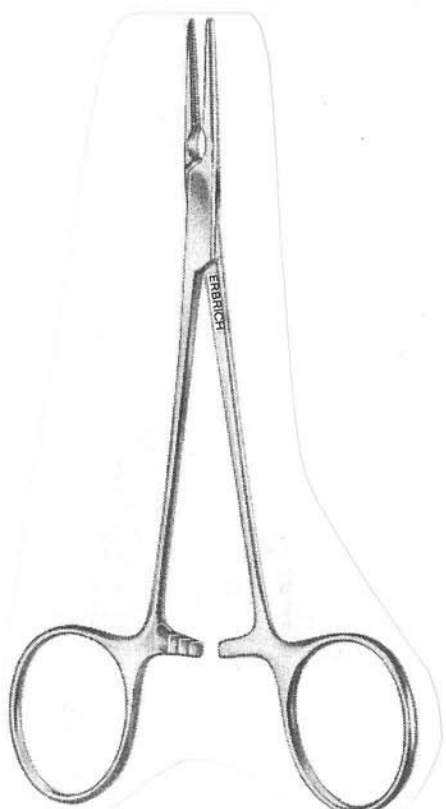

DeBakey-Pean

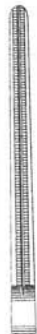

23E-108

14 cm



23E-109

16 cm



23E-110

18 cm



23E-111

20 cm



23E-112

14 cm



23E-113

16 cm



23E-114

18 cm



23E-115

20 cm

ATRAUMATISCHE GEFÄSSKLEMMEN
NON TRAUMATIC VASCULAR CLAMPS
PINCES VASCULAIRES à MORS NON TRAUMATISANTS



DeBakey-Rankin

16 cm



23E-118



23E-119

ATRAUMATISCHE GEFÄSSKLEMMEN
NON TRAUMATIC VASCULAR CLAMPS
PINCES VASCULAIRES à MORS NON TRAUMATISANTS

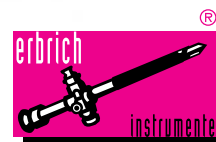

DeBakey



$\frac{1}{4}$
23E-120
12 cm



$\frac{1}{4}$
23E-121
17 cm



$\frac{1}{4}$
23E-122
21,5 cm



$\frac{1}{4}$
23E-123
23 cm



$\frac{1}{4}$
23E-124
27 cm



$\frac{1}{4}$
23E-125
31 cm

ATRAUMATISCHE GEFÄSSKLEMMEN
NON TRAUMATIC VASCULAR CLAMPS
PINCES VASCULAIRES à MORS NON TRAUMATISANTS



DeBakey

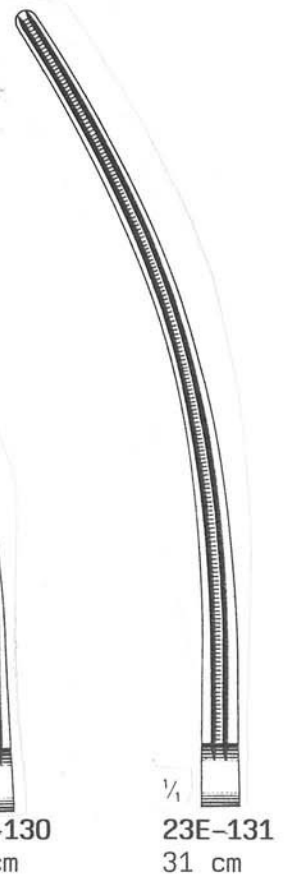
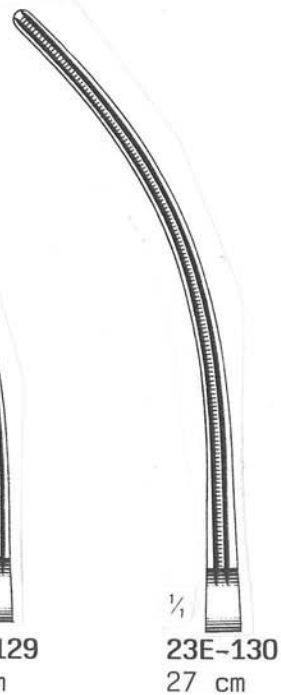
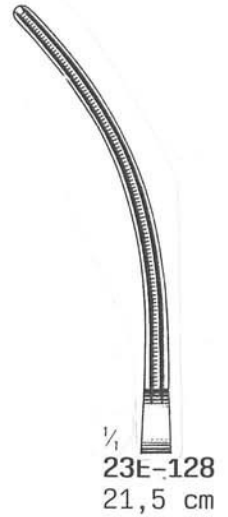
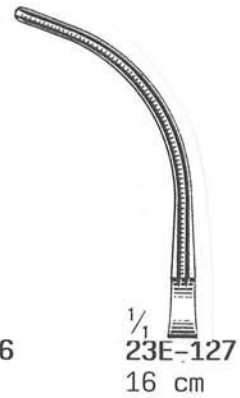

ATRAUMATISCHE GEFÄSSKLEMMEN
NON TRAUMATIC VASCULAR CLAMPS
PINCES VASCULAIRES à MORS NON TRAUMATISANTS



DeBakey

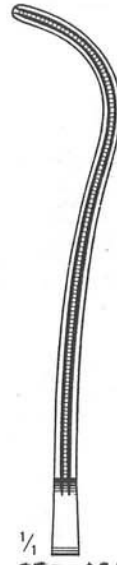

$\frac{1}{4}$
23E-132
 19 cm

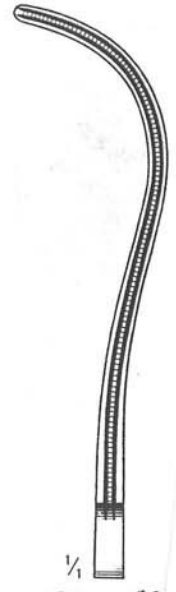

$\frac{1}{4}$
23E-133
 23 cm



$\frac{1}{4}$
23E-135
 17 cm



$\frac{1}{4}$
23E-136
 16 cm



23E-137
 17 cm

ATRAUMATISCHE GEFÄSSKLEMMEN
NON TRAUMATIC VASCULAR CLAMPS
PINCES VASCULAIRES à MORS NON TRAUMATISANTS

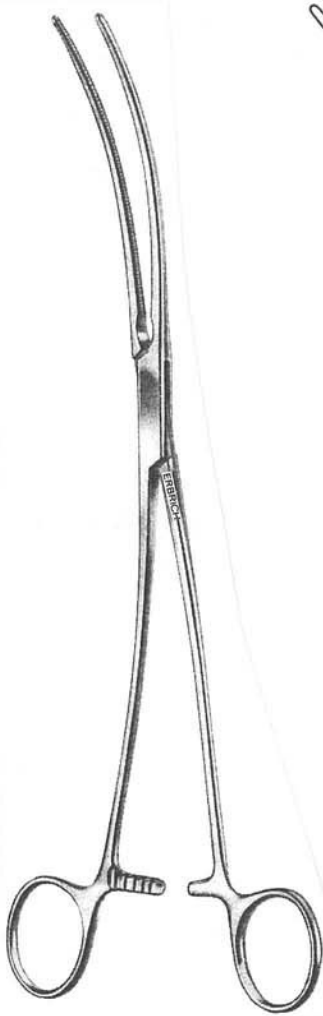

DeBakey

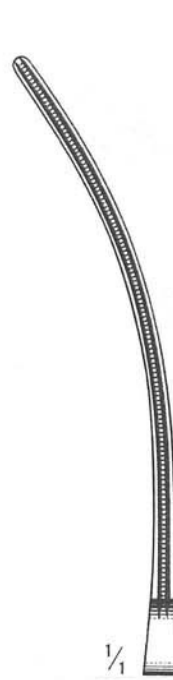

$\frac{1}{1}$
23E-140
26 cm

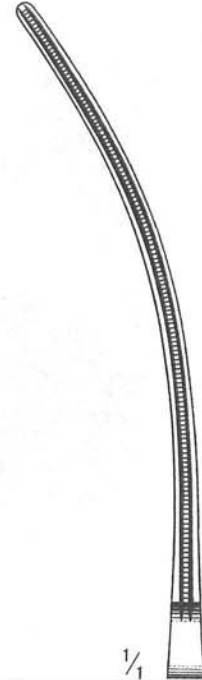

$\frac{1}{1}$
23E-141
27 cm

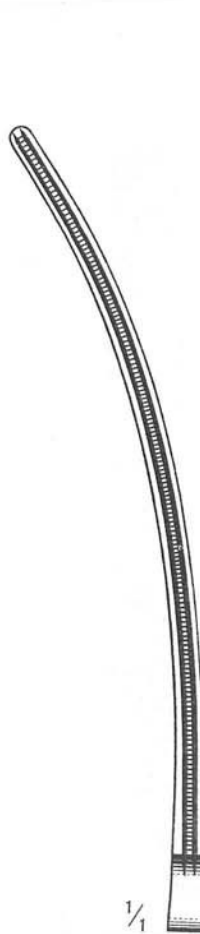

$\frac{1}{1}$
23E-142
31 cm

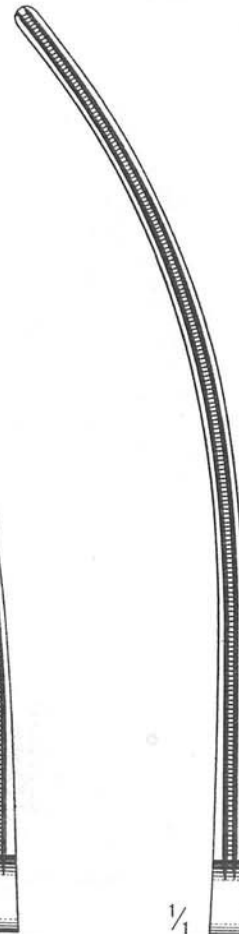

$\frac{1}{1}$
23E-143
33 cm

ATRAUMATISCHE GEFÄSSKLEMMEN
NON TRAUMATIC VASCULAR CLAMPS
PINCES VASCULAIRES à MORS NON TRAUMATISANTS

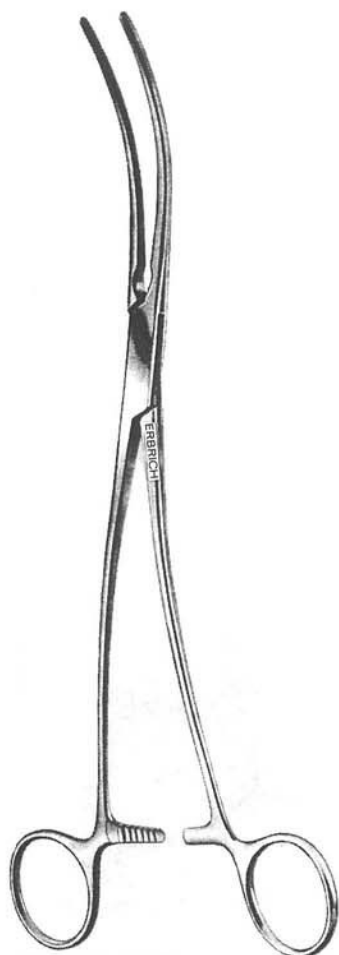

DeBakey

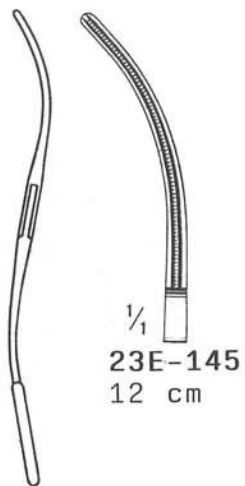

$\frac{1}{4}$
23E-145
12 cm

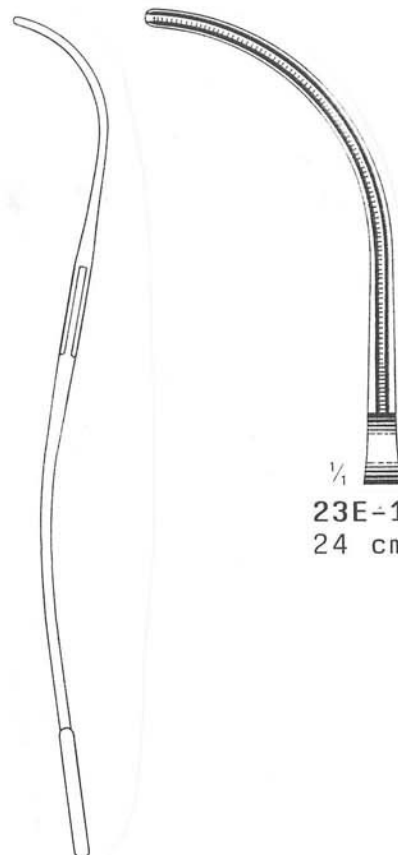

$\frac{1}{4}$
23E-146
24 cm



$\frac{1}{4}$
23E-147
19 cm

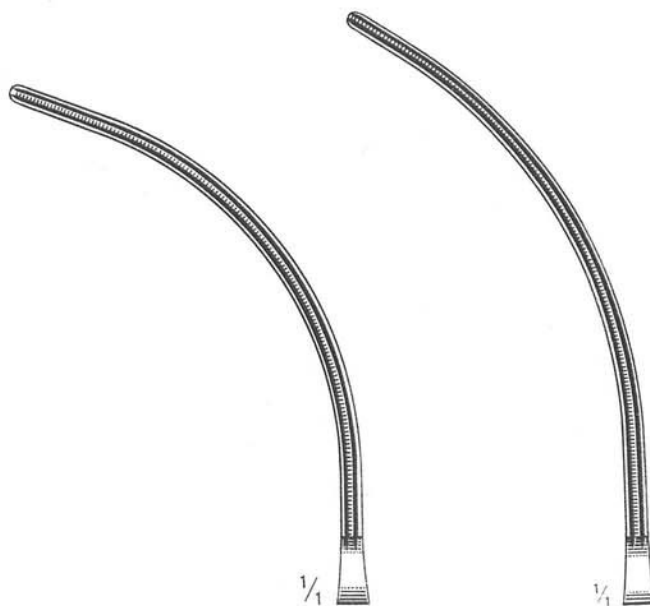

$\frac{1}{4}$
23E-148
20 cm

ATRAUMATISCHE GEFÄSSKLEMMEN
NON TRAUMATIC VASCULAR CLAMPS
PINCES VASCULAIRES à MORS NON TRAUMATISANTS



DeBakey

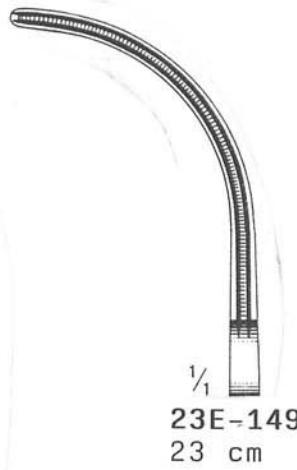

$\frac{1}{4}$
23E-149
23 cm



$\frac{1}{4}$
23E-150
24 cm

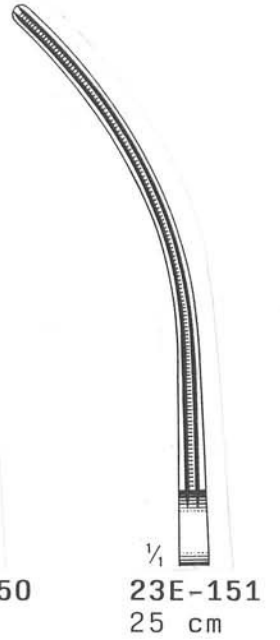

$\frac{1}{4}$
23E-151
25 cm

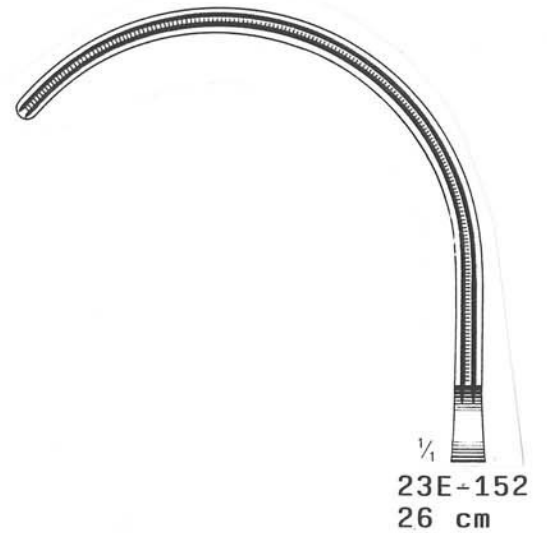

$\frac{1}{4}$
23E-152
26 cm

ATRAUMATISCHE GEFÄSSKLEMMEN
 NON TRAUMATIC VASCULAR CLAMPS
 PINCES VASCULAIRES à MORS NON TRAUMATISANTS

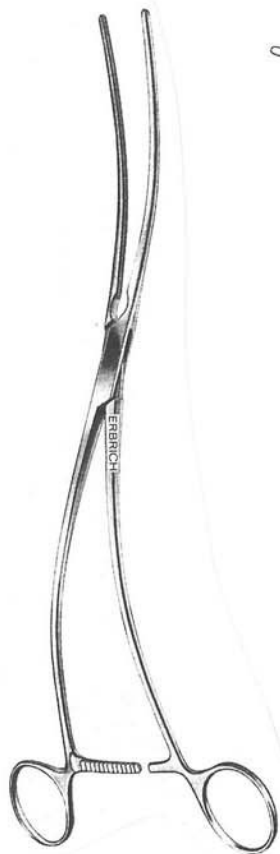
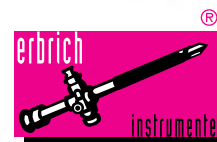

DeBakey

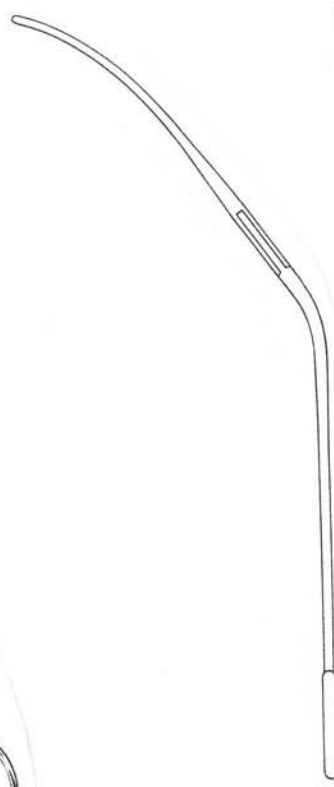

$\frac{1}{4}$
 23E-155
 28 cm



$\frac{1}{4}$
 23E-156
 30 cm



DeBakey



$\frac{1}{4}$
 23E-160
 24 cm



$\frac{1}{4}$
 23E-161
 25 cm

ATRAUMATISCHE GEFÄSSKLEMMEN
NON TRAUMATIC VASCULAR CLAMPS
PINCES VASCULAIRES à MORS NON TRAUMATISANTS



DeBakey

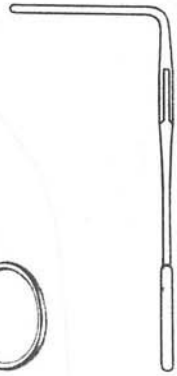

23E-165
10 cm



23E-166
17 cm



DeBakey



23E-170
16 cm

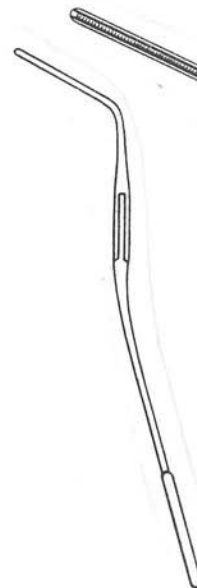

23E-171
15 cm

ATRAUMATISCHE GEFÄSSKLEMMEN
NON TRAUMATIC VASCULAR CLAMPS
PINCES VASCULAIRES à MORS NON TRAUMATISANT



DeBakey

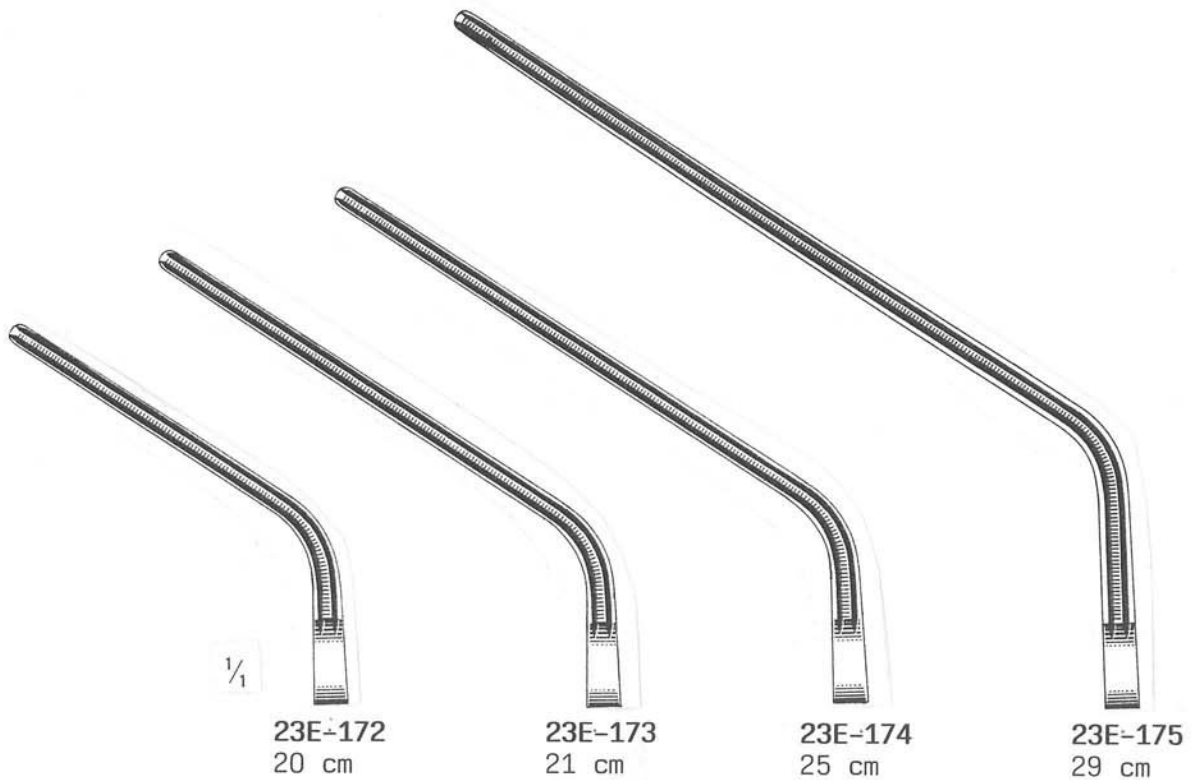

1/1

23E-172
20 cm

23E-173
21 cm

23E-174
25 cm

23E-175
29 cm

ATRAUMATISCHE GEFÄSSKLEMMEN
NON TRAUMATIC VASCULAR CLAMPS
PINCES VASCULAIRES à MORS NON TRAUMATISANTS



DeBakey

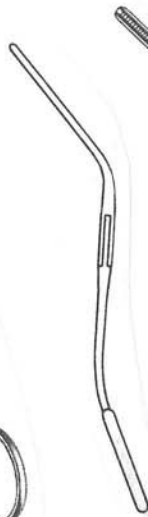

1/4

23E-176
13 cm



1/4

23E-177
20 cm



DeBakey

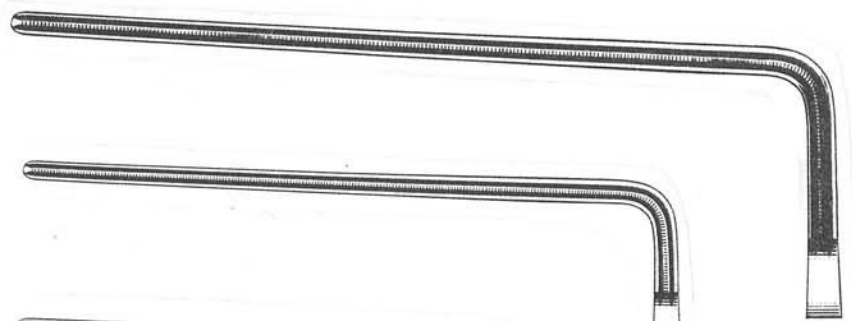

23E-182
27 cm

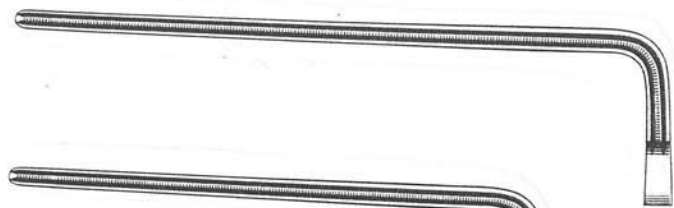

23E-181
23 cm

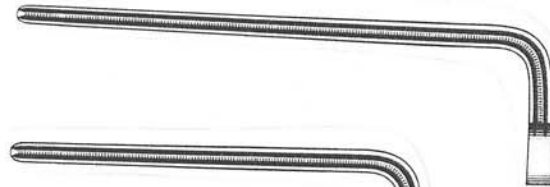

23E-180
19 cm



23E-179
18 cm

1/4

23E-178
15 cm

ATRAUMATISCHE GEFÄSSKLEMMEN
NON TRAUMATIC VASCULAR CLAMPS
PINCES VASCULAIRES à MORS NON TRAUMATISANTS

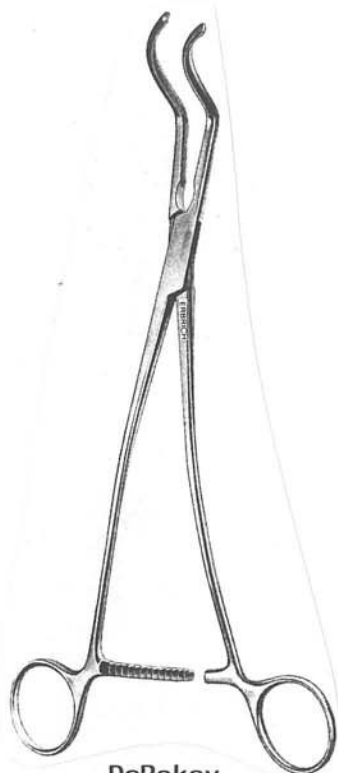

DeBakey

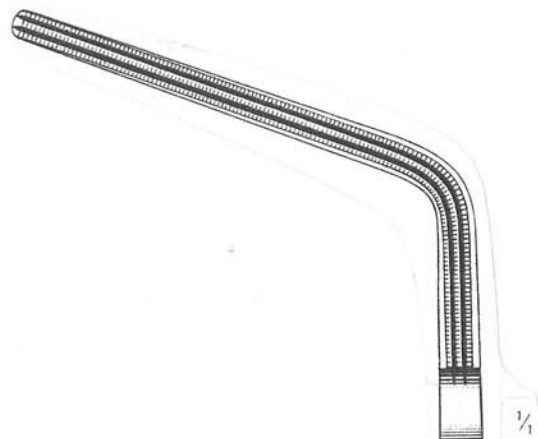

23E-185
27 cm

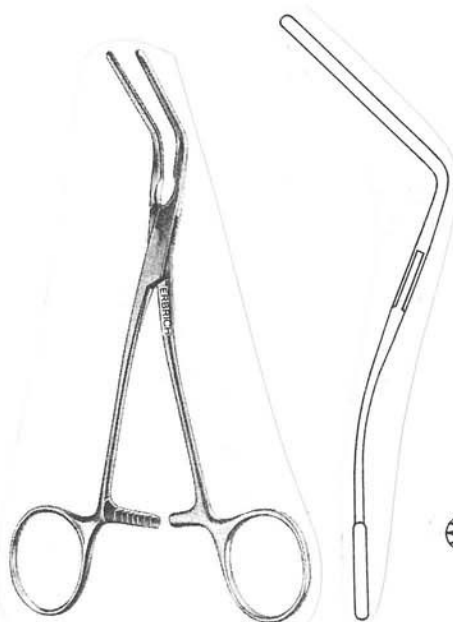

DeBakey-Morris

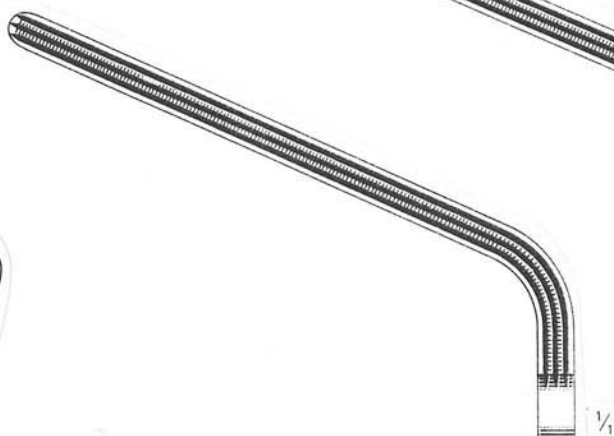

23E-187
25 cm

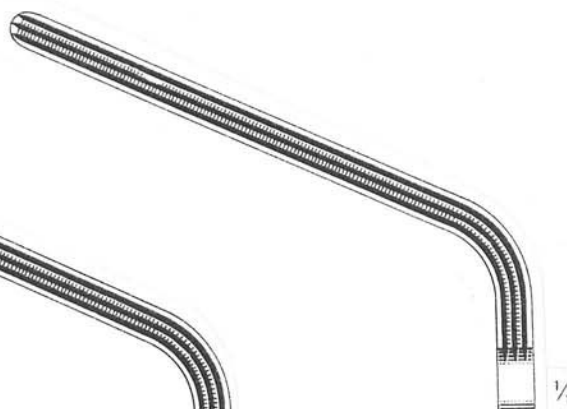

23E-186
20 cm

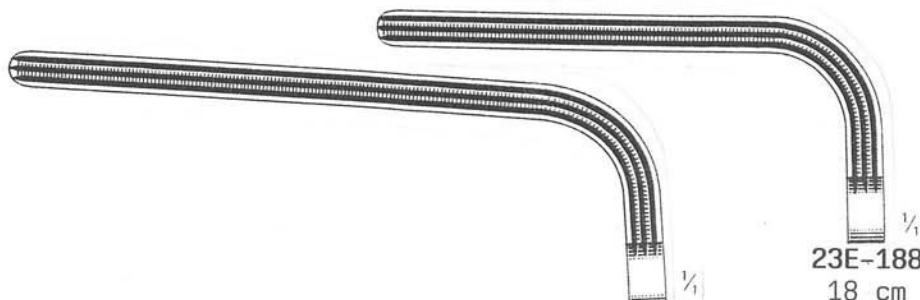

23E-188
18 cm

23E-189
23 cm

ATRAUMATISCHE GEFÄSSKLEMMEN
NON TRAUMATIC VASCULAR CLAMPS
PINCES VASCULAIRES à MORS NON TRAUMATISANTS

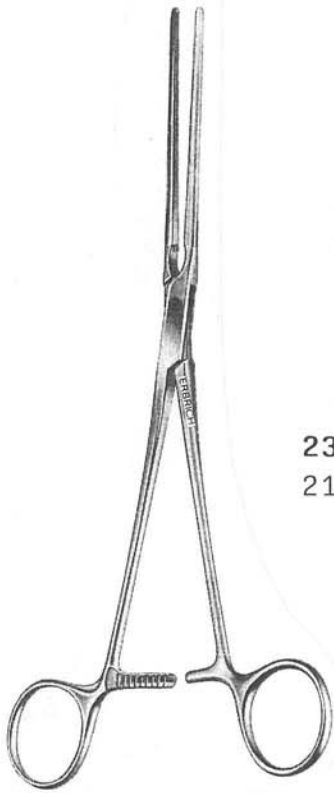

Potts

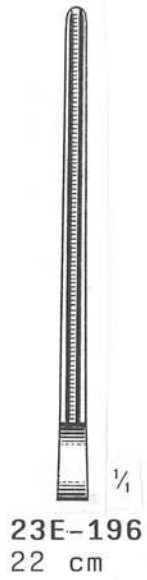

Potts

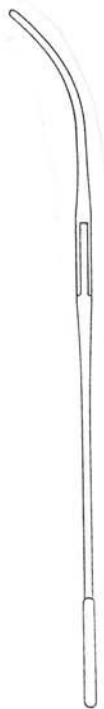

ATRAUMATISCHE GEFÄSSKLEMMEN
NON TRAUMATIC VASCULAR CLAMPS
PINCES VASCULAIRES à MORS NON TRAUMATISANTS

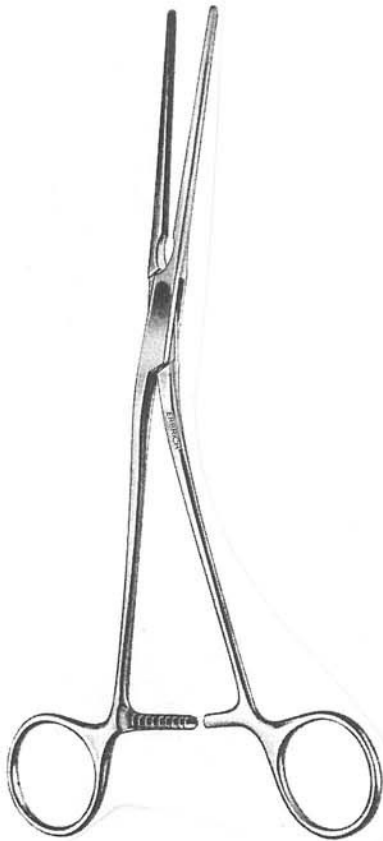

Potts

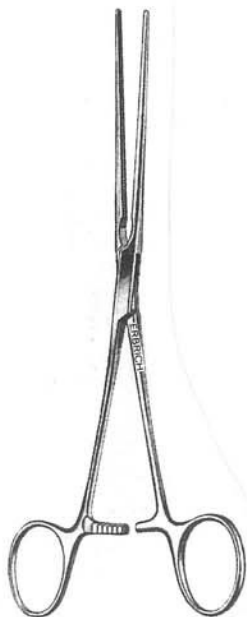

Bainbridge

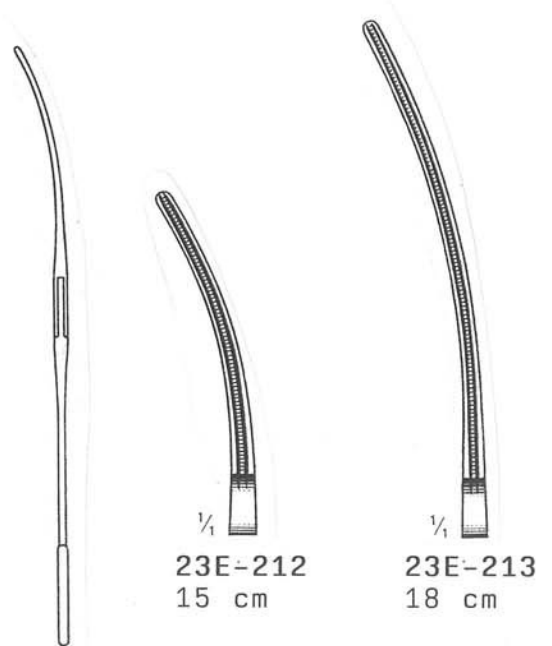
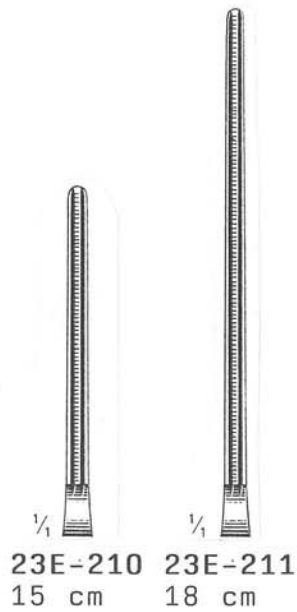

ATRAUMATISCHE GEFÄSSKLEMMEN
NON TRAUMATIC VASCULAR CLAMPS
PINCES VASCULAIRES à MORS NON TRAUMATISANTS

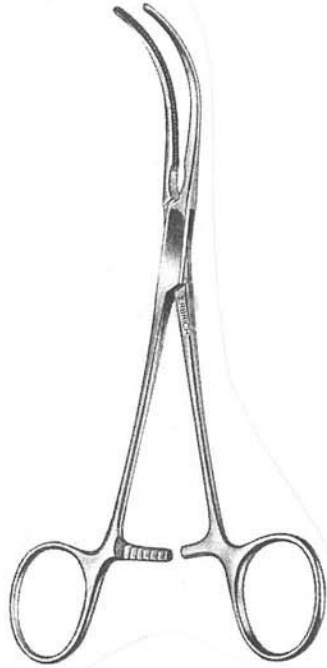

Glover



$\frac{1}{4}$
23E-215
17 cm



Leland-Jones

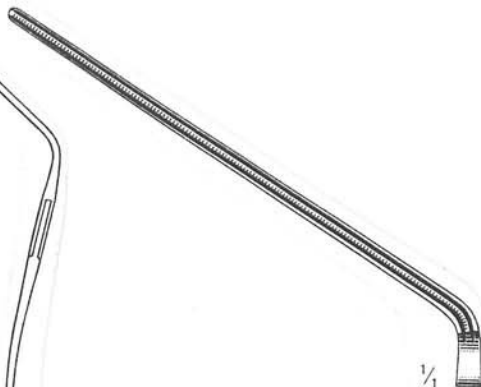

$\frac{1}{4}$
23E-220
18 cm

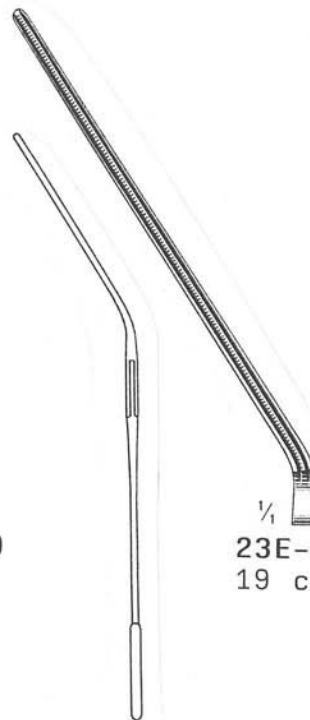

$\frac{1}{4}$
23E-221
19 cm



$\frac{1}{4}$
23E-222
20 cm

ATRAUMATISCHE GEFÄSSKLEMMEN
NON TRAUMATIC VASCULAR CLAMPS
PINCES VASCULAIRES à MORS NON TRAUMATISANTS



Harken



$\frac{1}{4}$
23E-225
24 cm



$\frac{1}{4}$
23E-226
24 cm

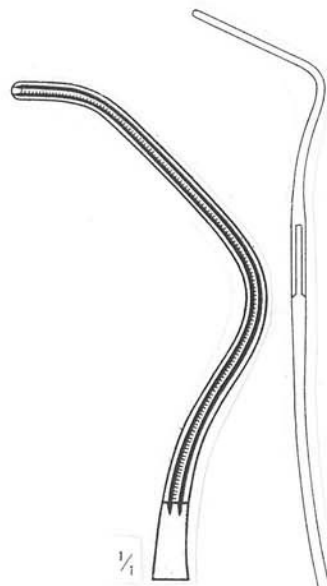

$\frac{1}{4}$
23E-227
24 cm



$\frac{1}{4}$
23E-228
24 cm

ATRAUMATISCHE GEFÄSSKLEMMEN
NON TRAUMATIC VASCULAR CLAMPS
PINCES VASCULAIRES à MORS NON TRAUMATISANTS



Beck

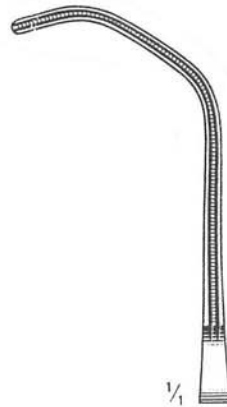

$\frac{1}{4}$
23E-230
17 cm



Derra

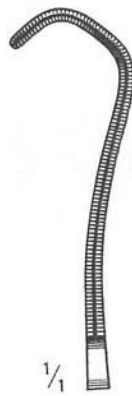

$\frac{1}{4}$
23E-235
16 cm

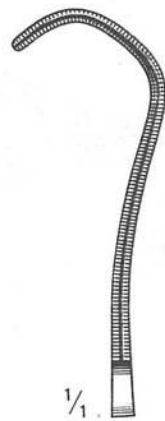

$\frac{1}{4}$
23E-236
17 cm

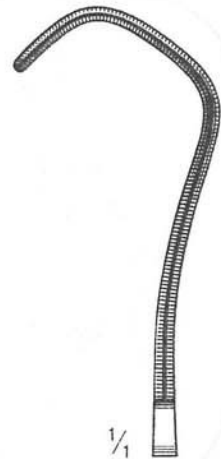

$\frac{1}{4}$
23E-237
18 cm

ATRAUMATISCHE GEFÄSSKLEMMEN
NON TRAUMATIC VASCULAR CLAMPS
PINCES VASCULAIRES à MORS NON TRAUMATISANTS

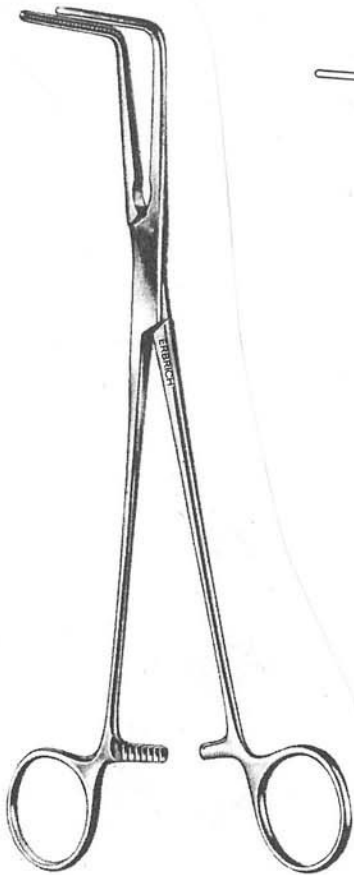

Lees

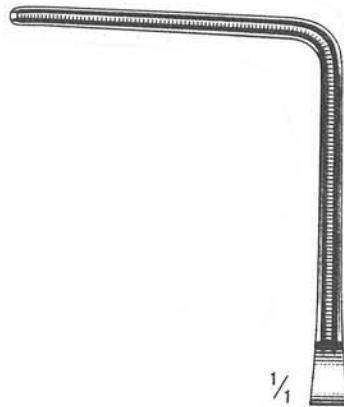

$\frac{1}{4}$
23E-240
23 cm

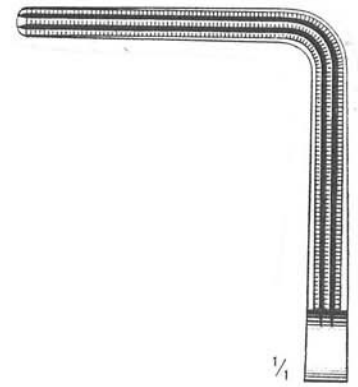

$\frac{1}{4}$
23E-241
25 cm

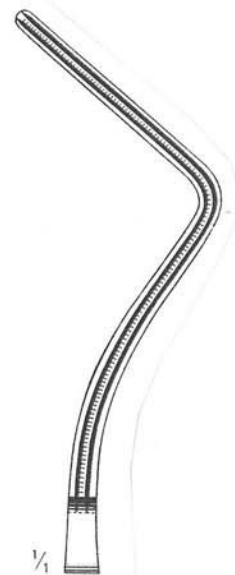

$\frac{1}{4}$
23E-242
25 cm

ATRAUMATISCHE GEFÄSSKLEMMEN
NON TRAUMATIC VASCULAR CLAMPS
PINCES VASCULAIRES à MORS NON TRAUMATISANTS



1/4
23E-243
20,5 cm

23E-244
24 cm

23E-245
25 cm

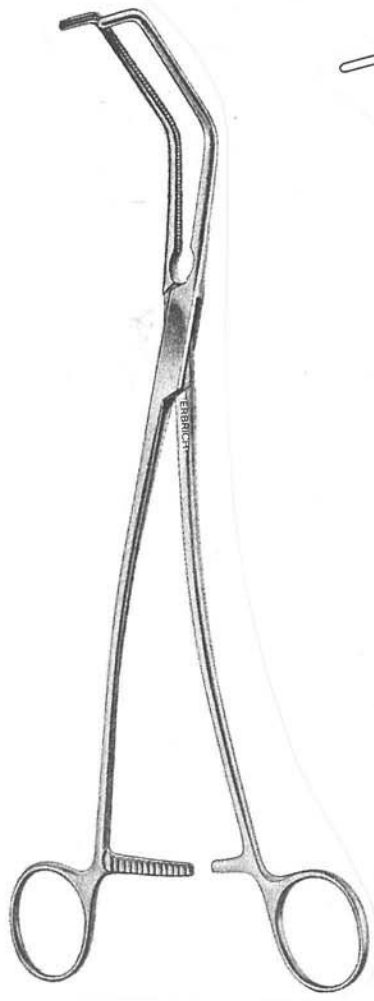

Satinsky



23E-246
26,5 cm

23E-247
27,5 cm

ATRAUMATISCHE GEFÄSSKLEMMEN
NON TRAUMATIC VASCULAR CLAMPS
PINCES VASCULAIRES à MORS NON TRAUMATISANTS

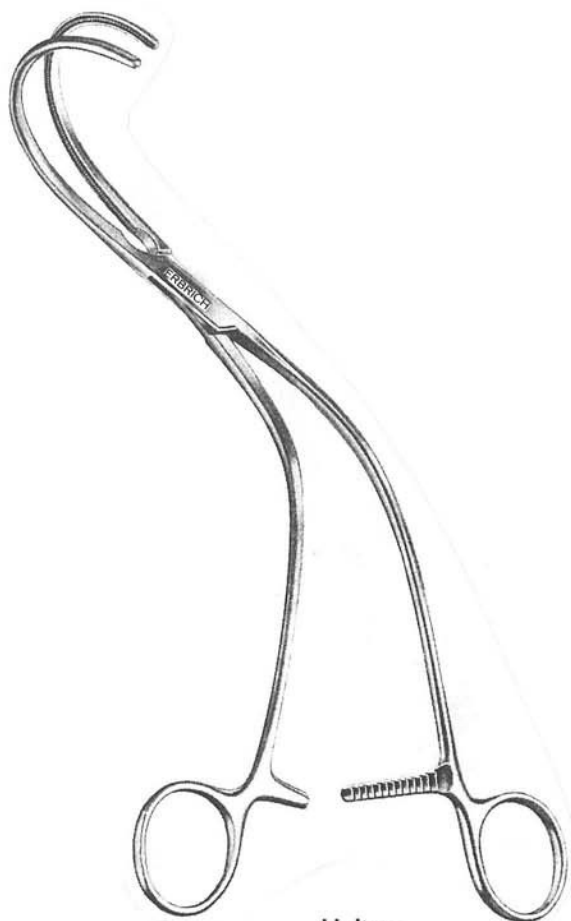

Weber
26 cm



23E-250

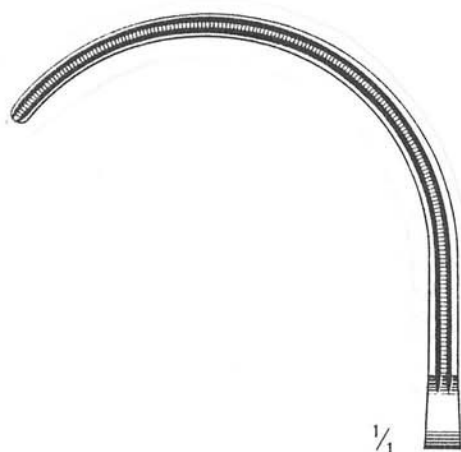

23E-251

ATRAUMATISCHE GEFÄSSKLEMMEN
NON TRAUMATIC VASCULAR CLAMPS
PINCES VASCULAIRES à MORS NON TRAUMATISANTS



Lambert-Kay

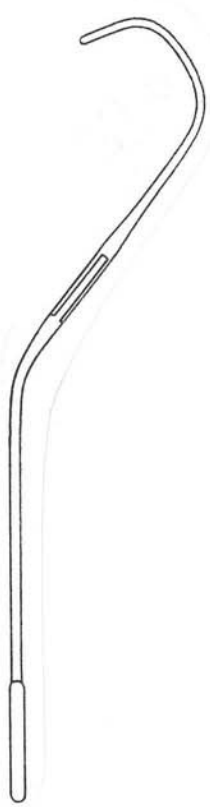

$\frac{1}{4}$
23E-255
21 cm



$\frac{1}{4}$
23E-256
22 cm

ATRAUMATISCHE GEFÄSSKLEMMEN
 NON TRAUMATIC VASCULAR CLAMPS
 PINCES VASCULAIRES à MORS NON TRAUMATISANTS

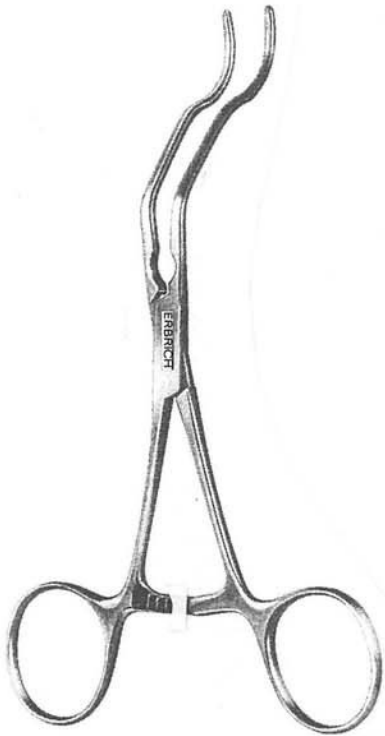

DeBakey-Gregory

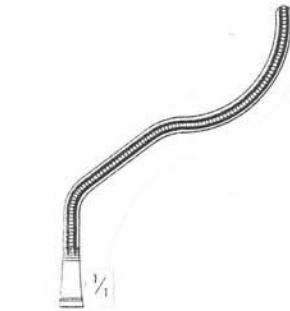

23E-260
14 cm



23E-261
16 cm

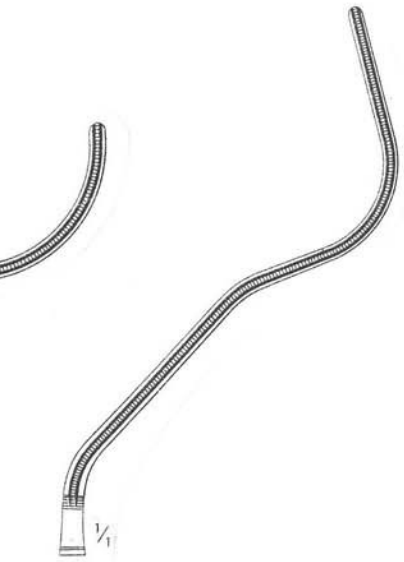

23E-262
18 cm

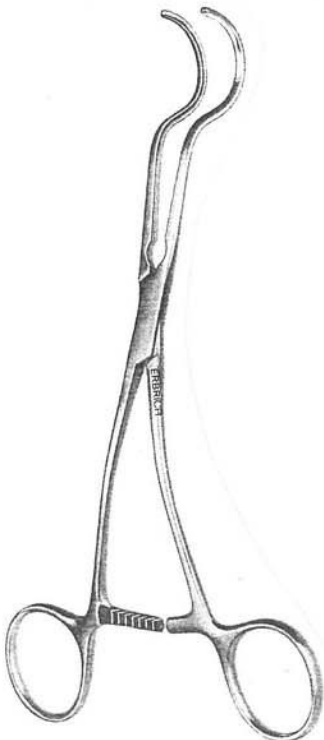

DeBakey-Dale



23E-265
17 cm

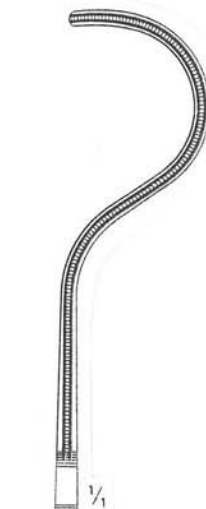

23E-266
17 cm



23E-267
18 cm

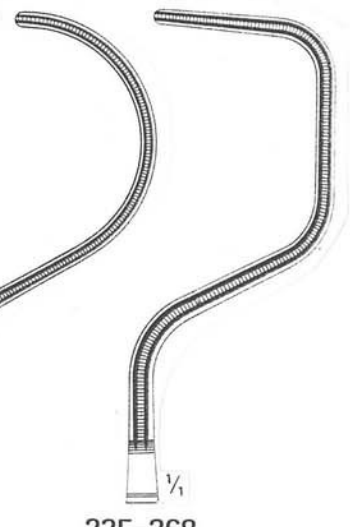

23E-268
18 cm

ATRAUMATISCHE GEFÄSSKLEMMEN
NON TRAUMATIC VASCULAR CLAMPS
PINCES VASCULAIRES à MORS NON TRAUMATISANTS

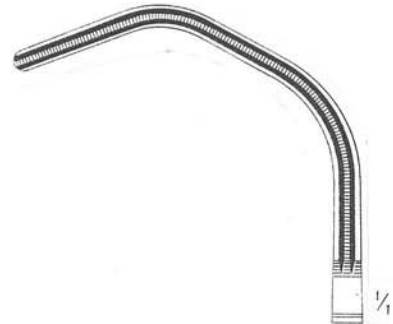
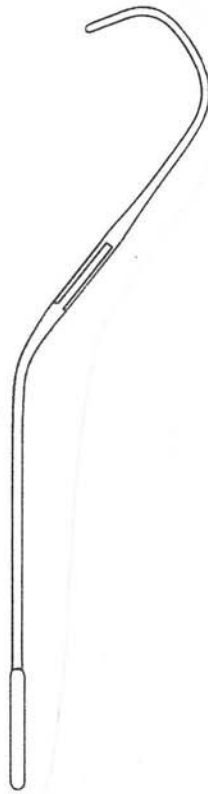

DeBakey-Dietrich
23E-280
21 cm



DeBakey-Ochsner
23E-290
23 cm

ATRAUMATISCHE GEFÄSSKLEMMEN
 NON TRAUMATIC VASCULAR CLAMPS
 PINCES VASCULAIRES à MORS NON TRAUMATISANTS

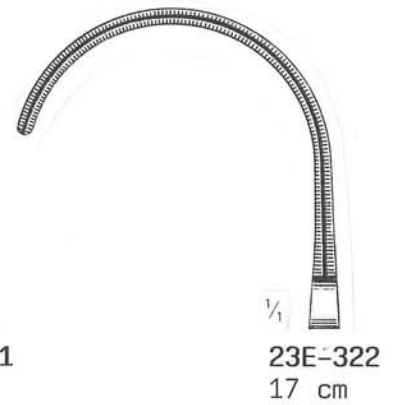
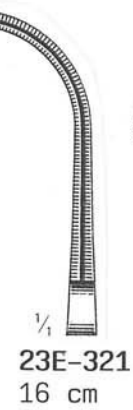
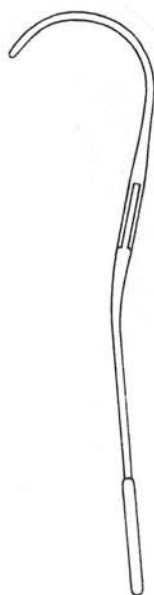
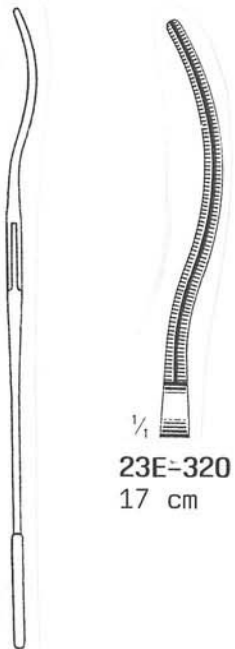
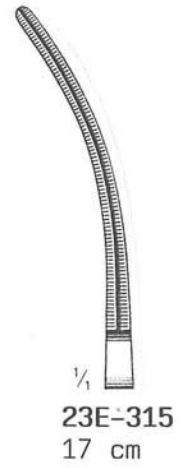
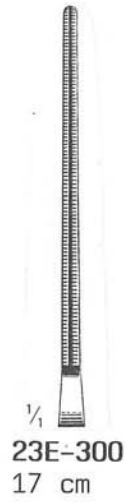

ATRAUMATISCHE GEFÄSSKLEMMEN
NON TRAUMATIC VASCULAR CLAMPS
PINCES VASCULAIRES à MORS NON TRAUMATISANTS

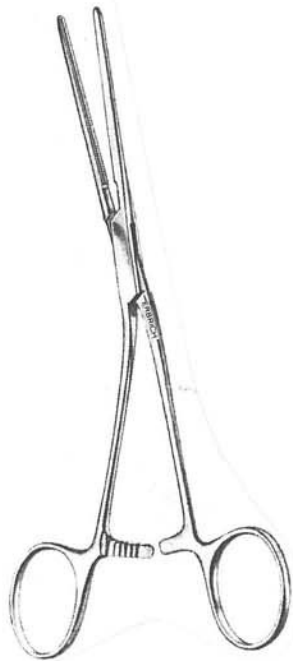

Cooley

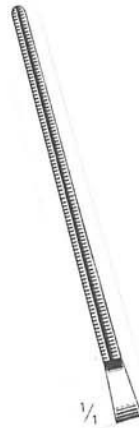

1/4

23E-330
17 cm

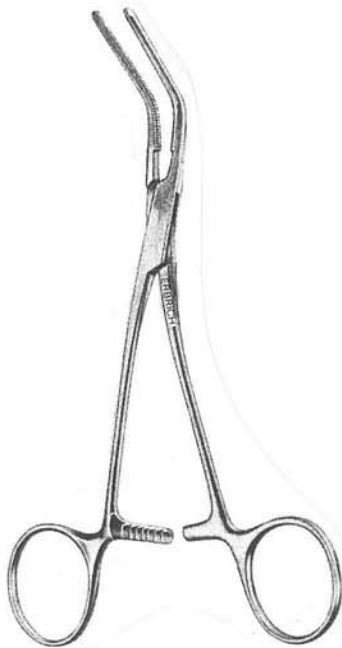

Colley

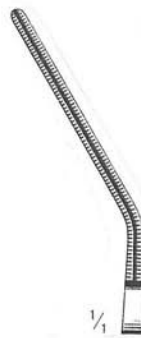

1/4

23E-335
17 cm

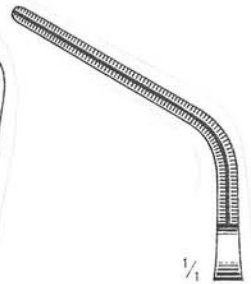
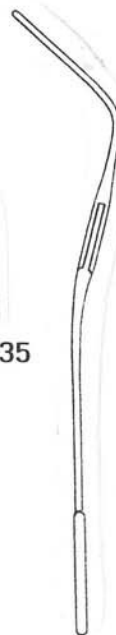

1/4

23E-336
15,5 cm

ATRAUMATISCHE GEFÄSSKLEMMEN
NON TRAUMATIC VASCULAR CLAMPS
PINCES VASCULAIRES à MORS NON TRAUMATISANTS

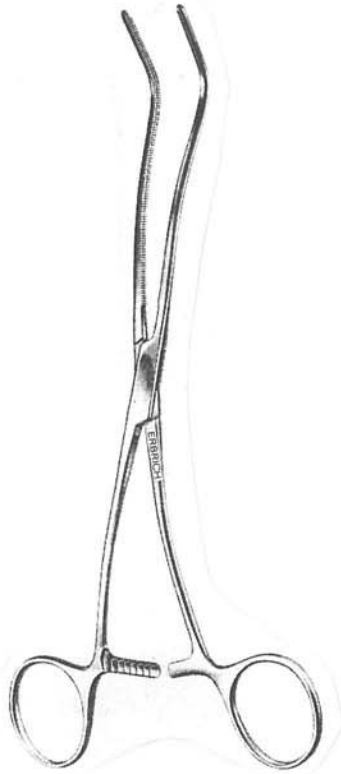

Cooley



23E-338
20 cm



Cooley

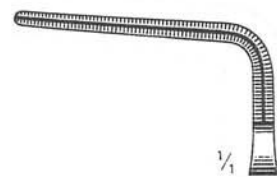

23E-340
15 cm

ATRAUMATISCHE GEFÄSSKLEMMEN
NON TRAUMATIC VASCULAR CLAMPS
PINCES VASCULAIRES à MORS NON TRAUMATISANTS

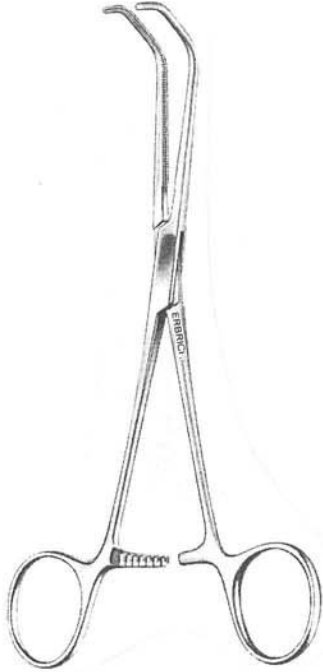

Cooley-Beck

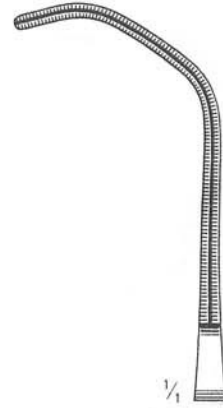
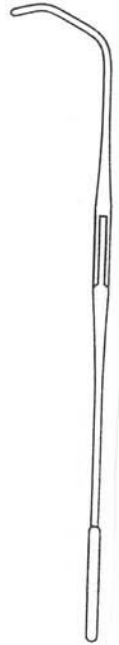

$\frac{1}{4}$
23E-355
17 cm

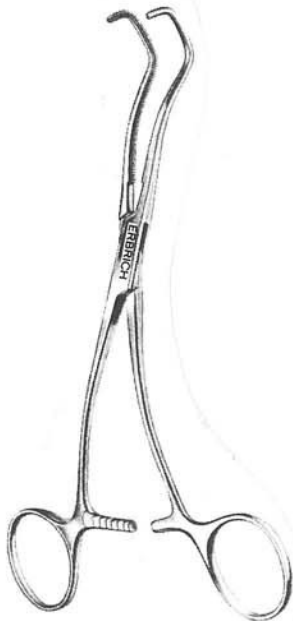

Cooley-Derra

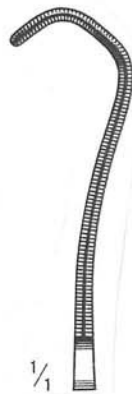

$\frac{1}{4}$
23E-360
16 cm

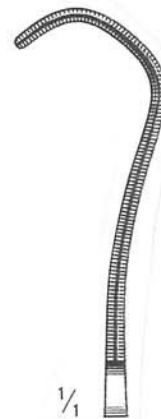

$\frac{1}{4}$
23E-361
17 cm

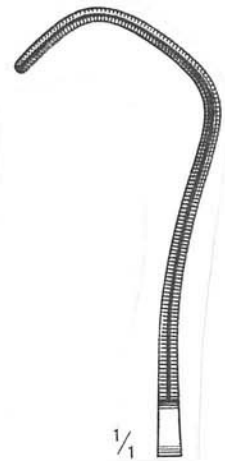

$\frac{1}{4}$
23E-362
18 cm

GEFÄSS-KLEMMEN
BLOOD VESSEL CLAMPS
PINCES VASCULAIRES

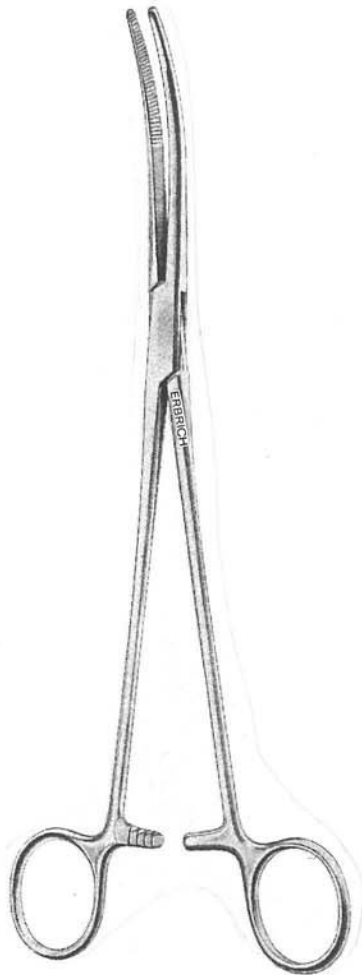

Rumel
23 cm



1/1

23E-500



1/1

23E-501

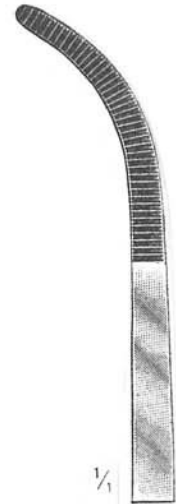

1/1

23E-502

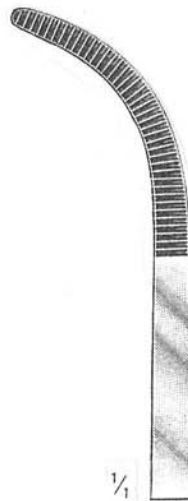

1/1

23E-503



1/1

23E-504

GEFÄSS-KLEMMEN
BLOOD VESSEL CLAMPS
PINCES VASCULAIRES



Baby-Satinsky
23E-510 15cm

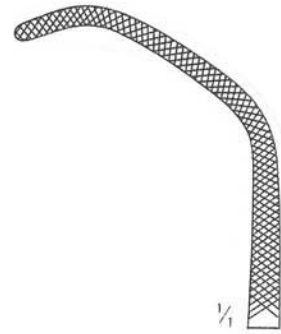

Satinsky
26,5 cm

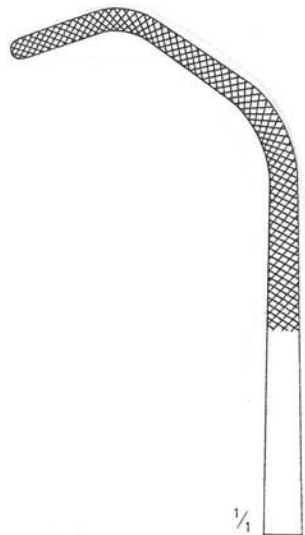

23E-511

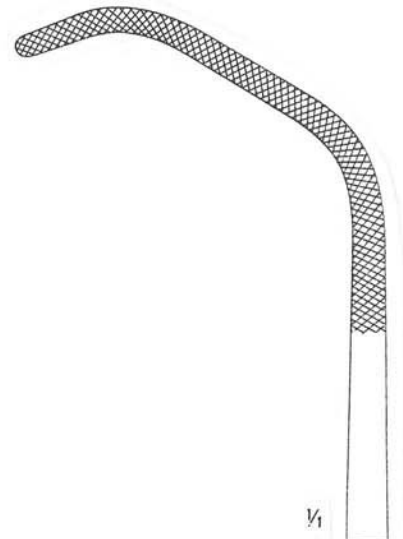

23E-512

GEFÄSS-KLEMMEN
BLOOD VESSEL CLAMPS
PINCES VASCULAIRES

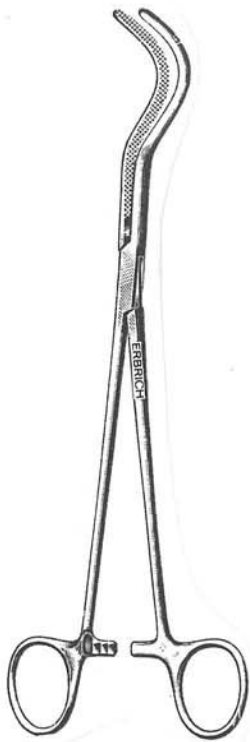

Harken
24 cm



23E-520



23E-521



23E-522

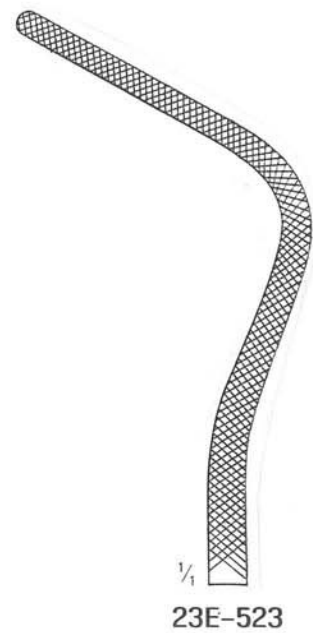

23E-523

GEFÄSS-KLEMMEN
BLOOD VESSEL CLAMPS
PINCES VASCULAIRES

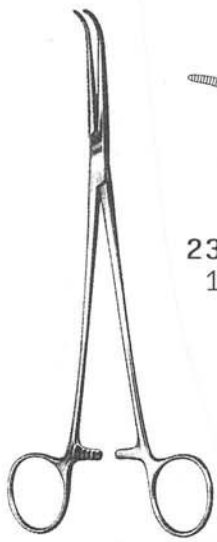

Gemini

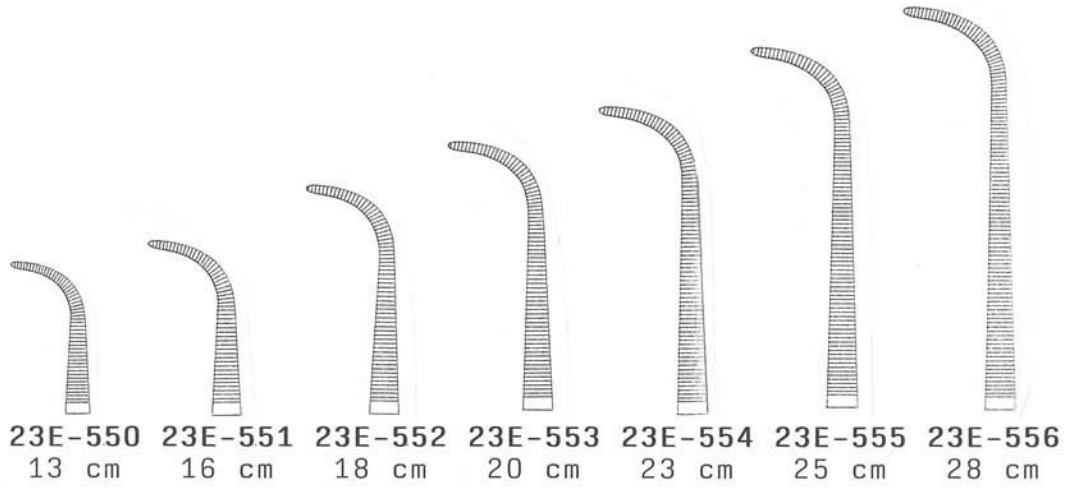

Mini-Gemini

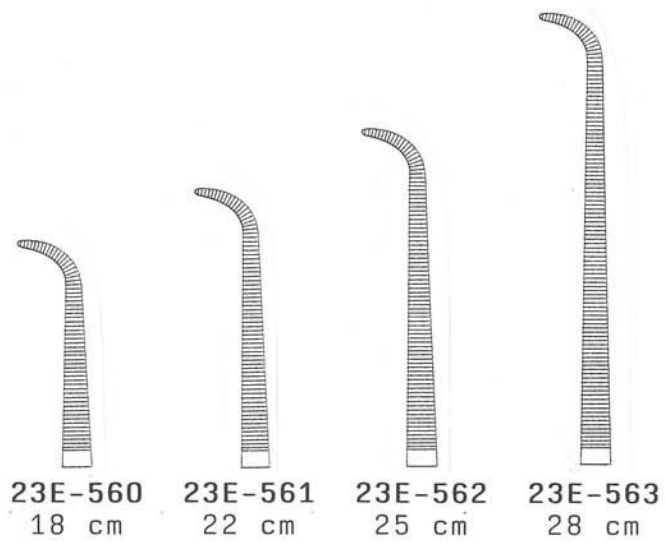

NEONATL- UND KINDERKLEMMEN
NEONATAL AND PEDIATRIC CLAMPS
PINCES VASCULAIRES NEONATAL ET PEDIATRIC



DeBakey-Subramanian
Mini, 15,5 cm
23E-600

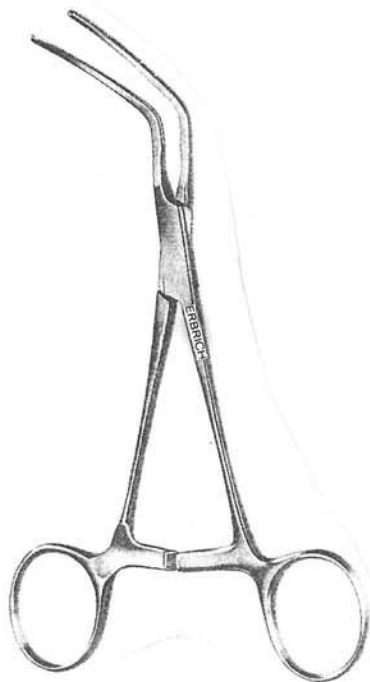
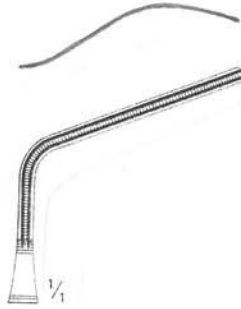

DeBakey-Subramanian
16 cm

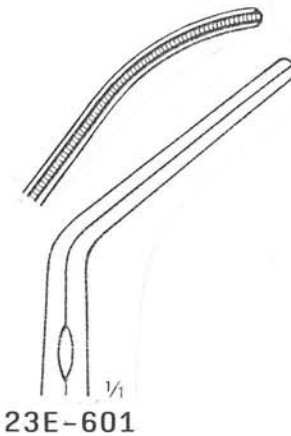

23E-601

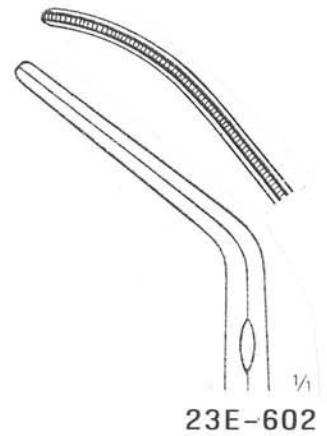

23E-602



Cooley

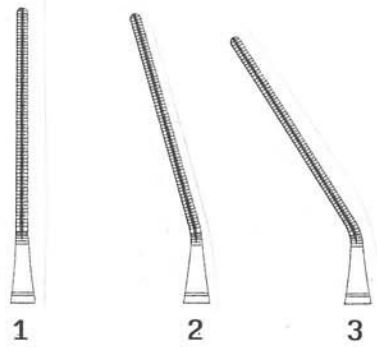

1

2

3

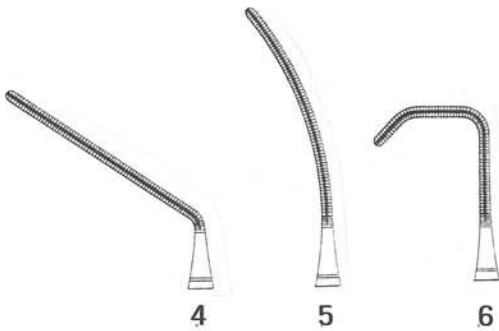

4

5

6

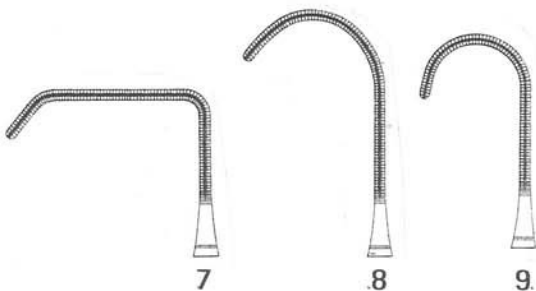

7

8

9

Fig.

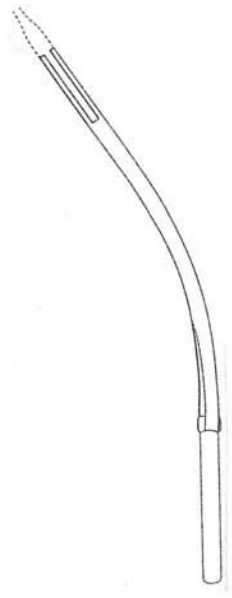
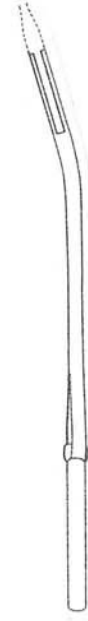

1	23E-620 14,5 cm	23E-630 14,5 cm	23E-640 14 cm
2	23E-621 14,5 cm	23E-631 14,5 cm	23E-641 14 cm
3	23E-622 14,5 cm	23E-632 14,5 cm	23E-642 14 cm
4	23E-623 13,5 cm	23E-633 13,5 cm	23E-643 13 cm
5	23E-624 14 cm	23E-634 14 cm	23E-644 13,5 cm
6	23E-625 13,5 cm	23E-635 13,5 cm	23E-645 13 cm
7	23E-626 13,5 cm	23E-636 13,5 cm	23E-646 13 cm
8	23E-627 14 cm	23E-637 14 cm	23E-647 13,5 cm
9	23E-628 13,5 cm	23E-638 13,5 cm	23E-648 13 cm

NEONATL- UND KINDERKLEMMEN
 NEONATAL AND PEDIATRIC CLAMPS
 PINCES VASCULAIRES NEONATAL ET PEDIATRIC



Cooley

23E-660
14 cm

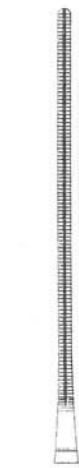

23E-662
16,5 cm



23E-670
14 cm



23E-675
14 cm

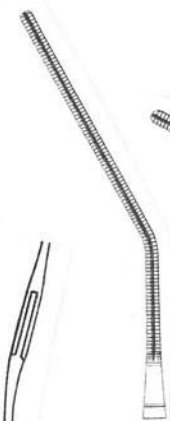

23E-680
16 cm



23E-681
15 cm

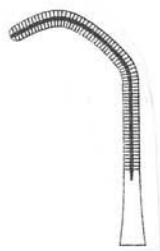

23E-685
14 cm

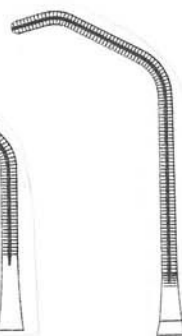

23E-686
15 cm

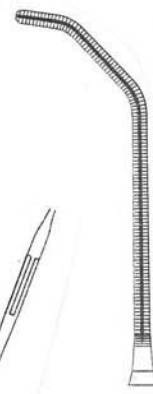

23E-689
15,5 cm

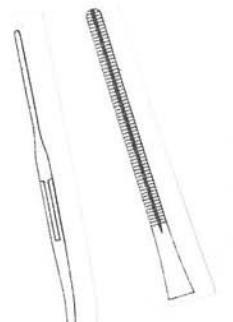

23E-695
14 cm

